

HYDRAULIC DIRECTIONAL CONTROL VALVES РАСПРЕДЕЛИТЕЛИ ГИДРАВЛИЧЕСКИЕ

Type: P80

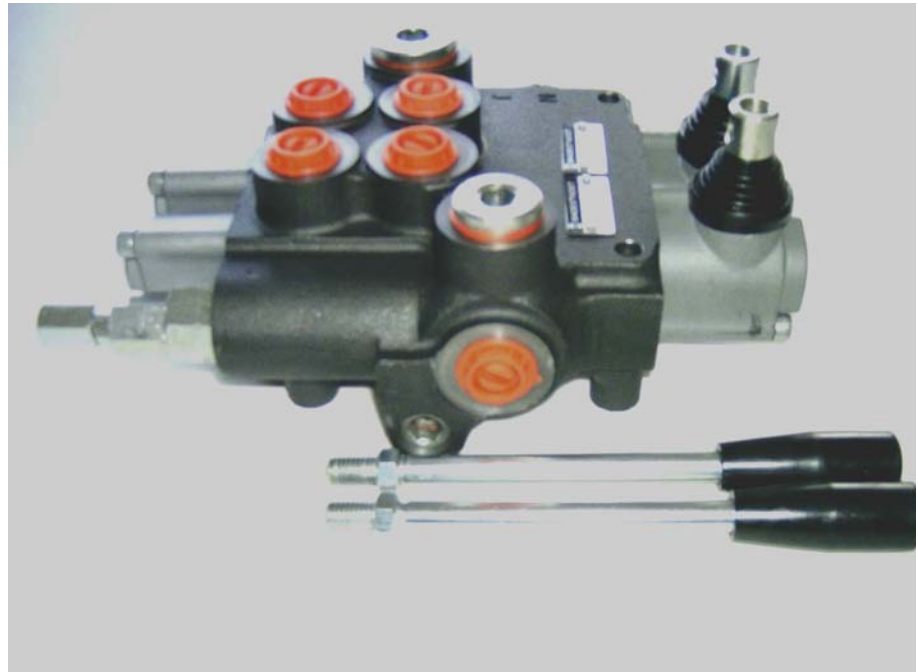

Description

Назначение и область применения

For starting, controlling and stopping the working fluid between the generator of pressured flow, the consumers at the Tank. Предназначен для изменения направления потока, ограничения давления рабочей жидкости гидролиниях, разгрузки насоса в нейтральной позиции золотников.

Specifications

Основные показатели:

1. Valve monoblock

Конструктивное выполнение

моноблок

2. Mounting

Крепление

3 bolts M8

3. Pressure connections

Присоединительные отверстия

internal thread

4. Ambient temperature

Температура воздуха

внутренние резьбы

5. Pressure medium

Рабочая жидкость

-40C...+60C

6. Viskosity

Кинематическая вязкость

mineral oil based hydraulic oil

7. Fluid temperature

8. Filtration

9. Max. operating pressure

Давление max. bar

12...800 mm²/s permissible range
20...100 mm²/s recommended range

- 15C...+80C

Oil contamination 10 to NAS1638

P = 250 bar

T = 50 bar

A, B = 300 bar

18 cm³/min at 120 bar

10. Leakage

Внутренние потери (A, B – T)

80 l/min (see “operating” diagram)

11. Nominal flow

Разход рабочей жидкости

12. Spool stroke

Ход золотника

± 7 mm

13. Actuating force

< 220 N in spool axis direction

directional control valve P80

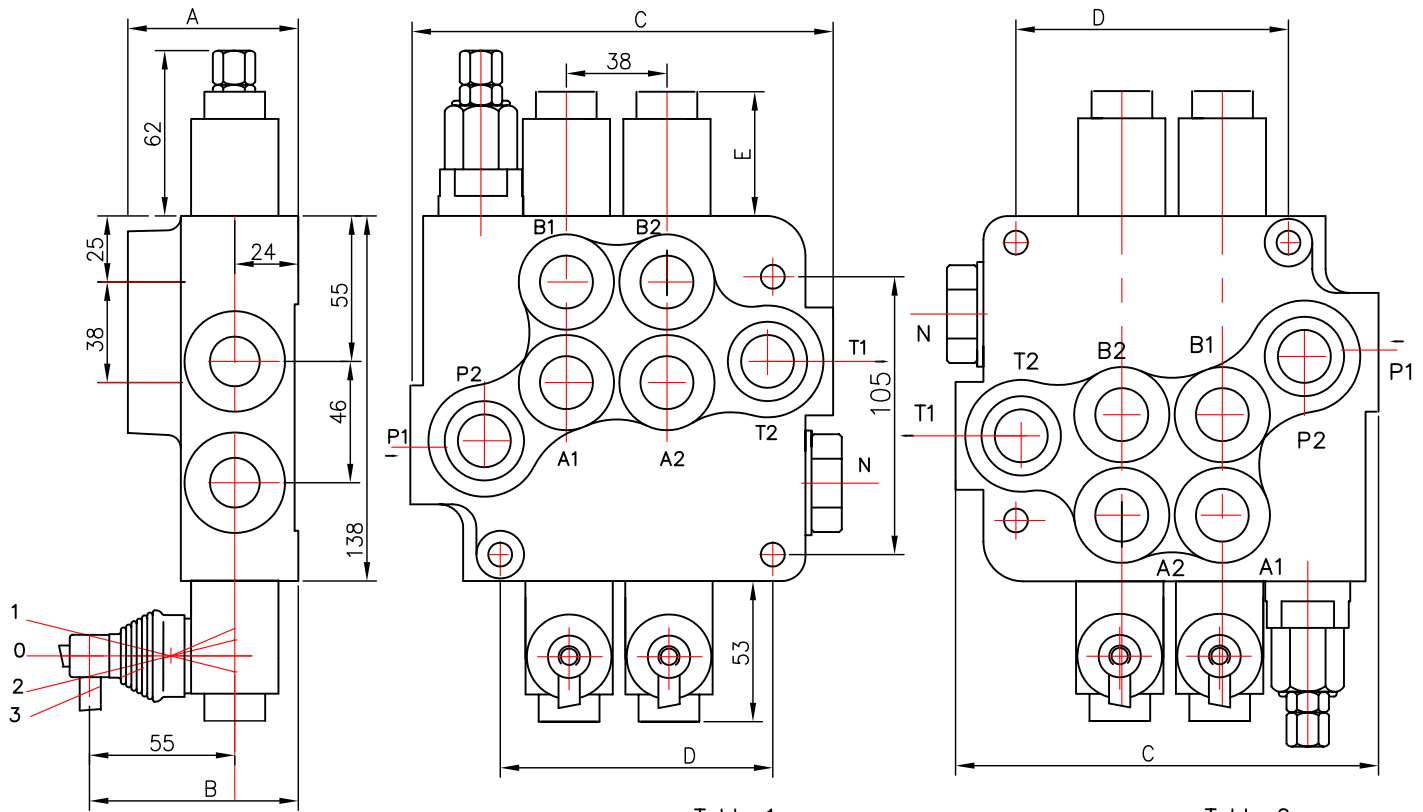

Table 1

	A	B	C	D	P1	P2	T1	T2
P80	65	79	107	65	*	*	-	-
2P80	80	94	160	103	*	*	*	*
3P80	80	94	198	141	*	*	*	*
4P80	80	94	242	179	*	*	*	*
5P80	80	94	280	217	*	*	*	*
6P80	80	94	318	255	*	*	*	*

Table 2

Spool control	E
1, 4, 5, 6, 7, 8, 9, 10, 11,	40
2, 3, 12, 14	72
13	44

- 0 block with common check valve / распределитель с общим клапаном
- 2 number of spools / количество золотников
- P80 directional control valve type ... / распределитель типа ...
- R inlet high pressure - right / вход высокого давления с правой стороны
- 1 way of distribution/parallel or ... / способ распределения потока
- A 1 first spool distribution type / характеристика первого золотника
- 1 spool control/detend and etc./ / контроль золотника/фиксации и груза/
- A 1 second spool distribution type / характеристика второго золотника
- 1 spool control/detend and estr./ / контроль золотника/фиксации и груза/
- G ports /treads/ / резьбовые отверстия
- KZ1 general operation feature / вид ручного управления
- T with "teton" / исполнение ручного управления с "тетон"
- H operation feature /pneumatic, ... / грузое управление
- E with electric switch / с электрическим выключателем
- C2 high pressure carry over / продолжительное течение высокого давления
- 11 connection ports in use / присоединительные отверстия

directional control valve P80

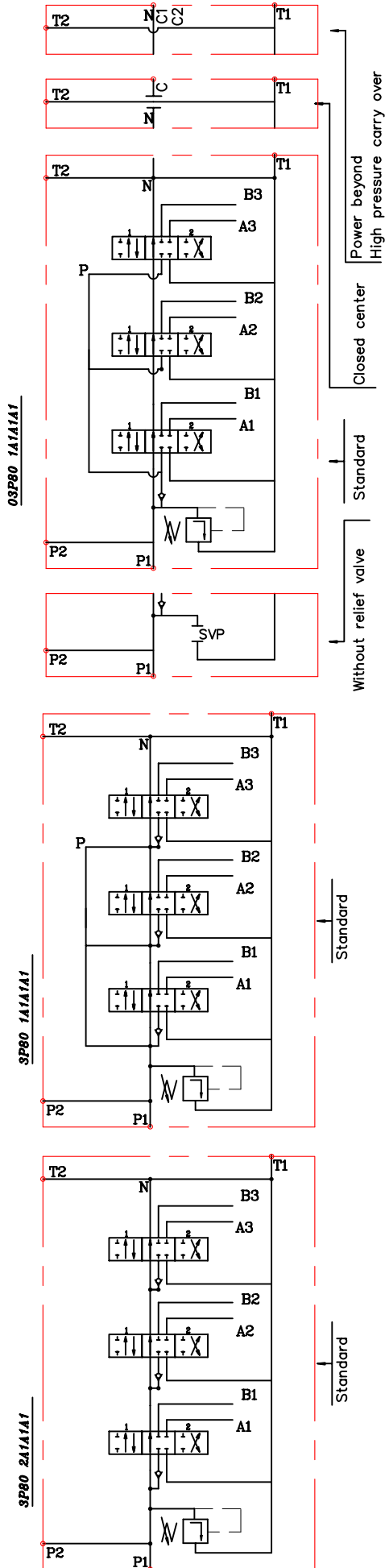

Table 3

code	Number of spools
	1
	2
	3

ets.

Table 4

code	Number of spools	code	way of distribution ; распределение потока
	1	1	parallel ; параллельное
	2	2	tandem(series parallel) ; серийно-параллельное

Table 5

code	spool type
A	
B	
C	
D	
E	
F	
G	
H	
M	
N	
O	
P	
Q	
R	
S	
T	
L	

Table 6

code	spool control
1	1 0 2
2	1 0 2
3	1 0 2
4	0 2
5	1 0
6	1 2
7	1 2
8	1 0 2
9	1 0
10	0 2
11	1 2
12	1 0 2 3
13	1 0 2 3

Table 7

code	с микро шалтер ; incorporated microswitch
E	 mikroswitch type Omron-V 165 I C5

Table 8

code	другое управление ; operation feature
P	 пневматическое on-off pneumatic control; 5-10 bar ; ports G1/4
H	 гидравлическое on-off hydraulic control ; pn = 5 - 20 bar ; ports G1/4

directional control valve P80

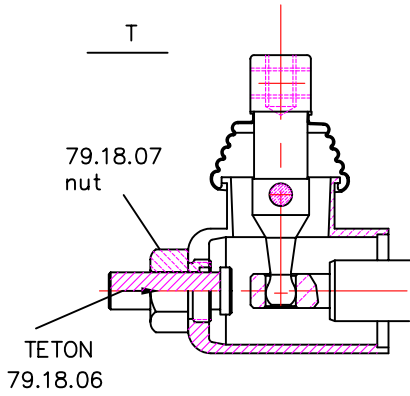

P80

Table 9

code	ports (treads) ; присоединительные отверстия			
	P	A ; B	T	N
M	M22x1.5	M22x1.5	M26x1.5	M26x1.5
G	G1/2	G1/2	G3/4	G3/4
S	7/8-14UNF	7/8-14UNF	1 1/16-14UNF	1 1/16-14UNF

kind of hand control ; вид ручного управления

Table 10

code	ескуз feature	code	ескуз feature	code	ескуз feature
KZ		KY		KI	
KZ1		KY1		KI1	
KZ0		KY0		KI0	
KZ01		KY01		KI01	
-	without hand control ; без лостова система за управление				

P80 directional control valve

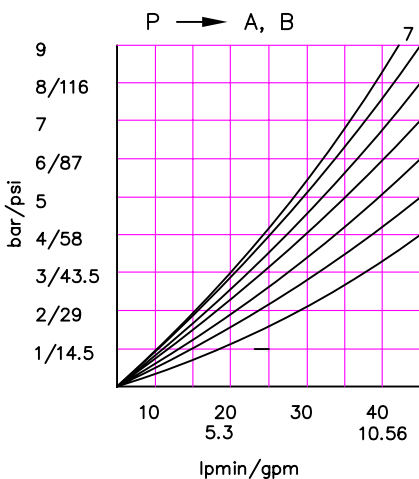
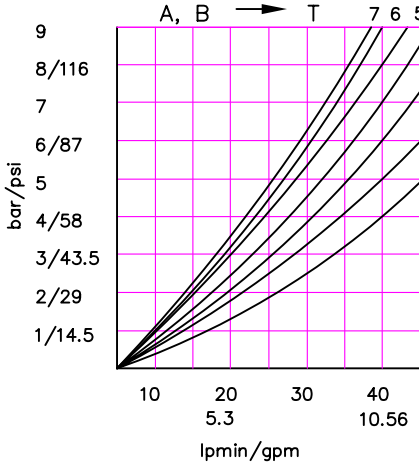
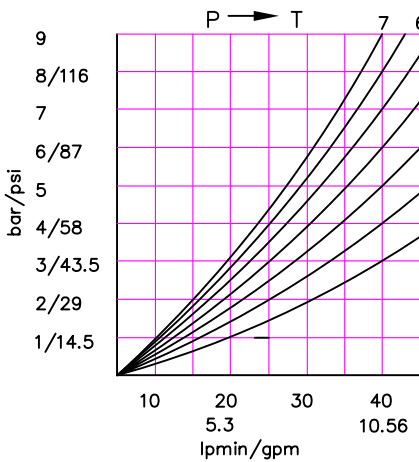

Table 11

code	вид продължение на дебита	
C	отвор "N" затворен closed center	
C1	отвор "N" продължава за следващ консуматор part for power beyond sleeve(carry over)	$\varnothing 14$ mm M22x1.5
C2	отвор "N" продължава за следващ консуматор part for power beyond sleeve(carry over)	G 1/2 M22x1.5
-	отвор "N" е свързан с "T" without part for pressure carry over	
X	отвор "N" е винаги свързан с "T" power beyond ever to tank	

Table 12

code	used connection ports ; присоединительные отверстия
11	P1 ; T1
12	P1 ; T2
21	P2 ; T1
22	P2 ; T2

REMOTE CONTROLS
 Управление тросом

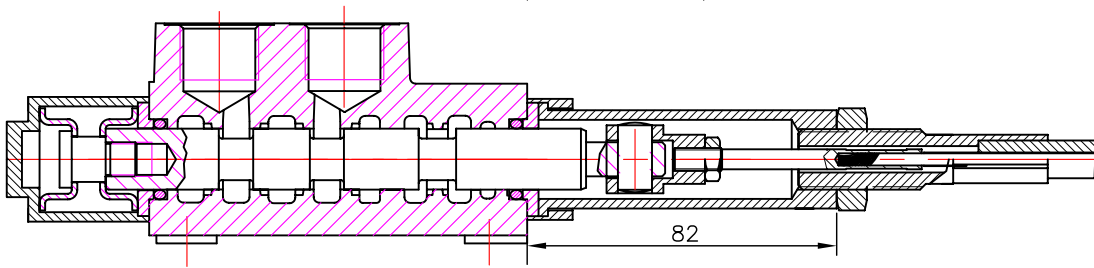

P80 A1G V1(l= . . .)+ 3047
 spool valve cable control body

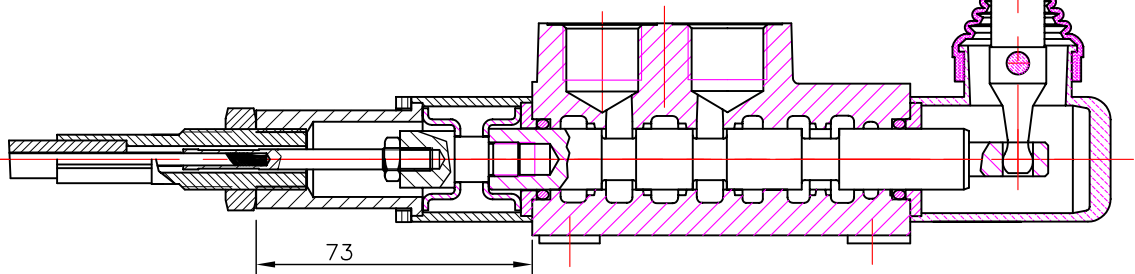

P80 A1G V2KZ1(l= . . .)+ 3047
 spool valve cable control body

Cable "INDEMAR" Cod. IT 3056 /l=1.00; 1.50; 2.00; 2.50; 3.00 m/
 +control body "INDEMAR"
 code 3047, 3076, 3077

Technical specifications			
	3047	3076	3077
Stroke	13+13 mm	13+13 mm	13+13 mm
Max. load	45 kg	45 kg	45 kg
Level ratio	10:1	10:1	10:1
Lock in neutral	No	No	Yes
Antireverse lock	No	Yes	No
Body colour	Black	Black	Black
Cables type	Heavy Duty	Heavy Duty	Heavy Duty
Operating temperature	-40/+80C	-40/+80C	-40/+80C

High solidity controls for easy mounting on every type of distributor. They can be mounted stand alone or packed together. They use push-pull heavy duty cables that provide a positive smooth operating lever and are manufactured in three different models to meet different needs of Clients.

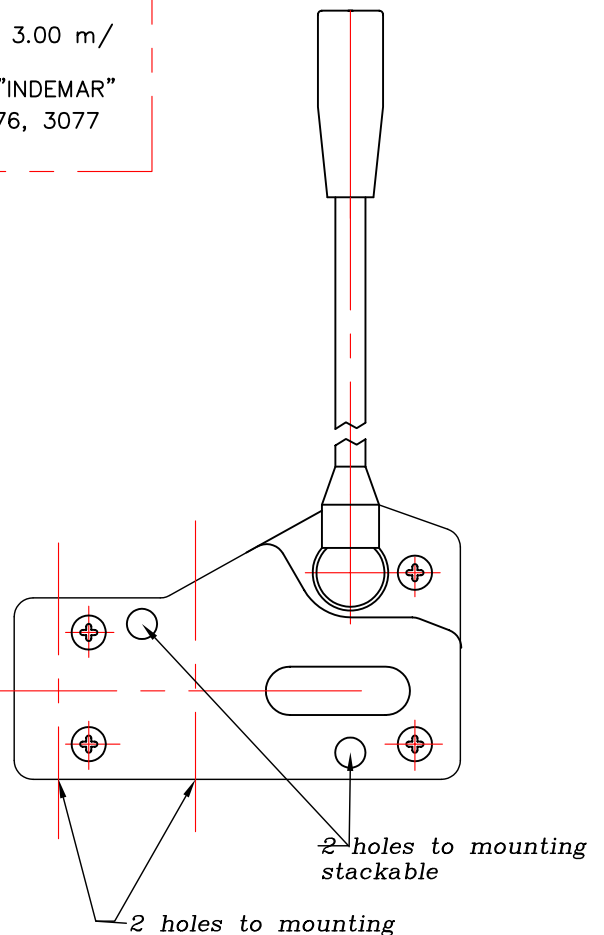

JOYSTICK "+"

This control gives the possibility to operate, at the same time two spools with a "+" movement.

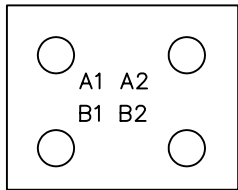
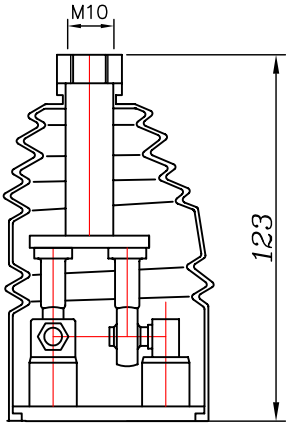

standard version 1

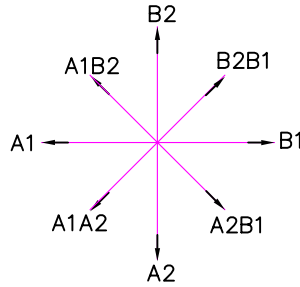
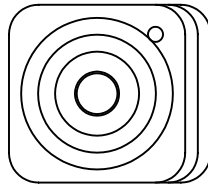

standard version 2

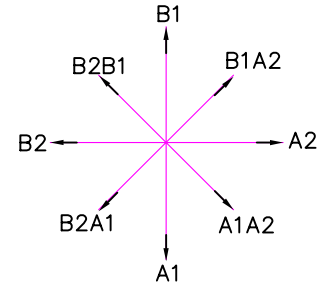
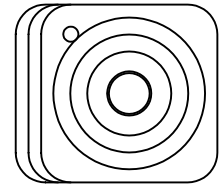

standard version 3

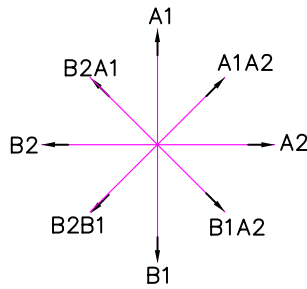
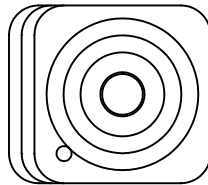

standard version 4

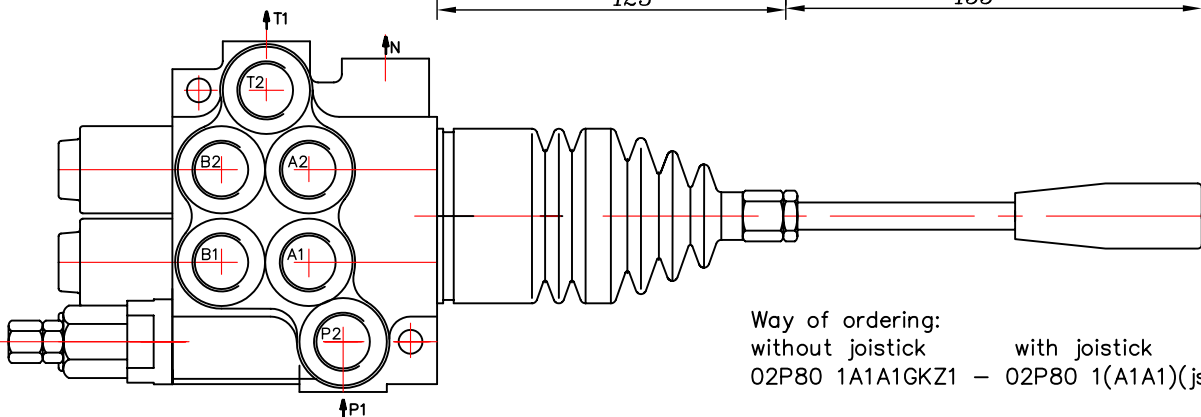
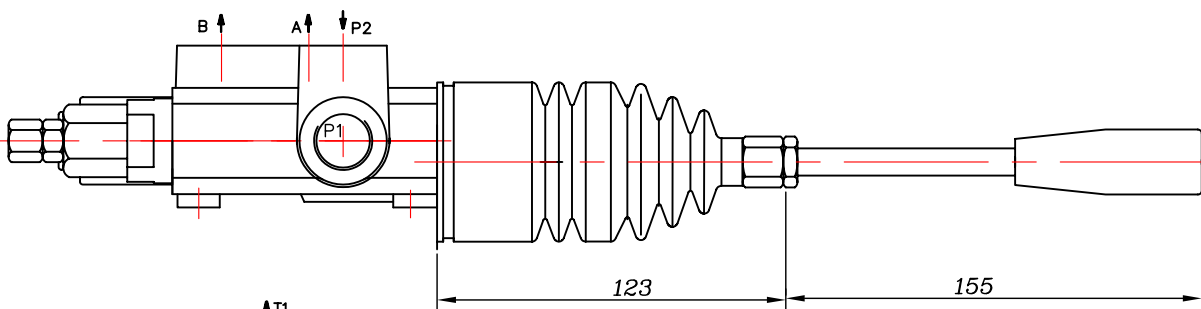
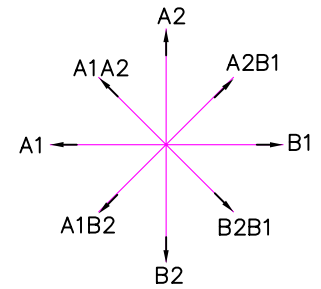
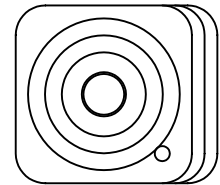

Way of ordering:
 without joystick with joystick
 O2P80 1A1A1GKZ1 - O2P80 1(A1A1)(js+3)G